

Operation & Installation Manual

Wireless Controller

- CIR01 -

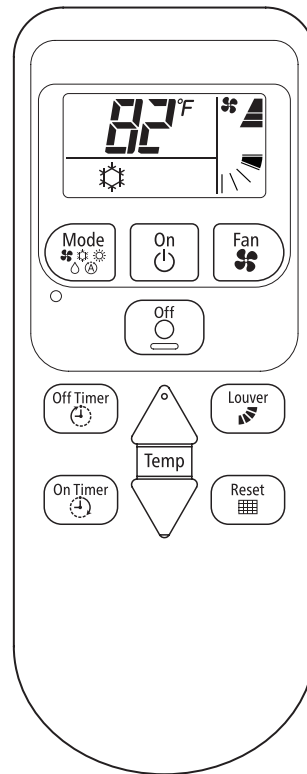

IMPORTANT:

*READ AND UNDERSTAND
THIS MANUAL BEFORE
USING THIS WIRELESS
CONTROLLER.
KEEP THIS MANUAL FOR
FUTURE REFERENCE.*



Important Notice

- Johnson Controls Inc. pursues a policy of continuing improvement in design and performance in its products. As such, Johnson Controls Inc. reserves the right to make changes at any time without prior notice.
- Johnson Controls Inc. cannot anticipate every possible circumstance that might involve a potential hazard.
- This heat pump air conditioning unit is designed for standard air conditioning applications only. Do not use this unit for anything other than the purposes for which it was intended for.
- The installer and system specialist shall safeguard against leakage in accordance with local pipefitter and electrical codes. The following standards may be applicable, if local regulations are not available. International Organization for Standardization: (ISO 5149 or European Standard, EN 378). No part of this manual may be reproduced in any way without the expressed written consent of Johnson Controls Inc. or York.
- This heat pump air conditioning unit will be operated and serviced in the United States of America and comes with a full complement of the appropriate Safety, Danger, and Caution, warnings.
- If you have questions, please contact your distributor or dealer.
- This manual provides common descriptions, basic and advanced information to maintain and service this heat pump air conditioning unit which you operate as well for other models.
- This manual should be considered as a permanent part of the air conditioning equipment and should remain with the air conditioning equipment.

Product Inspection upon Arrival

1. Upon receiving this product, inspect it for any damages incurred in transit. Claims for damage, either apparent or concealed, should be filed immediately with the shipping company.
2. Check the model number, electrical characteristics (power supply, voltage, and frequency rating), and any accessories to determine if they agree with the purchase order.
3. The standard utilization for this unit is explained in these instructions. Use of this equipment for purposes other than what it designed for is not recommended.
4. Please contact your local agent or contractor as any issues involving installation, performance, or maintenance arise. Liability does not cover defects originating from unauthorized modifications performed by a customer without the written consent of Johnson Controls, Inc. and York. Performing any mechanical alterations on this product without the consent of the manufacturer will render your warranty null and void.

Safety Messages

 WARNING	<p>Indicates a hazardous situation that, if not avoided, could result in death or serious injury.</p>
 CAUTION	<p>Indicates a hazardous situation that, if not avoided, could result in minor or moderate injury.</p>
NOTICE	<p>Indicates information considered important, but not hazard-related (for example, messages relating to property damage).</p>

General Precautions

 WARNING	<p>To reduce the risk of serious injury or death, read these instructions thoroughly and follow all warnings or cautions included in all manuals that accompanied the product and are attached to the unit. <i>Refer back to these safety instructions as needed.</i></p>
--	---

- This system, including this controller, should be installed by personnel certified by Johnson Controls, Inc. Personnel must be qualified according to local, state and national building and safety codes and regulations. Incorrect installation could cause leaks, electric shock, fire or an explosion. In areas where Seismic Performance requirements are specified, the appropriate measures should be taken during installation to guard against possible damage or injury that might occur in an earthquake. If the unit is not installed appropriately correctly, injuries may occur because of a falling unit.
- Use appropriate Personal Protective Equipment (PPE), such as gloves, protective goggles and electrical protection equipment and tools suited for electrical operation purposes.
- When transporting, be careful when picking up, moving and mounting these units. Although the controller may be packed using plastic straps, do not use them for transporting from one location to another. Do not stand on or put any material on the controller.
- When installing the controller cabling to the units, do not touch or adjust any safety devices inside the indoor or outdoor units. All safety features, disengagement, and interlocks must be in place and functioning correctly before the equipment is put into operation. If these devices are improperly adjusted or tampered with in any way, a serious accident can occur. Never bypass, wire around, or jump-out any safety device or switch.
- Use only Johnson Controls recommended, provided as standardized, or replacement parts.
- Johnson Controls shall will not assume any liability for injuries or damage caused by not following steps outlined or described in this manual. Unauthorized modifications to Johnson Controls products are prohibited as they...
 - May create hazards which could result in death, serious injury or equipment damage;
 - Will void product warranties;
 - May invalidate product regulatory certifications;
 - May violate OSHA standards;

NOTICE	<p>Take the following precautions to reduce the risk of property damage.</p>
---------------	--

- Do not touch the main circuit board or electronic components in the controller or remote devices. Make sure that dust and/or steam does not accumulate on the circuit board.
- When installing the unit in a hospital or other facility where electromagnetic waves are generated from nearby medical and/or electronic devices, be prepared for noise and electronic interference Electromagnetic Interference (EMI). Do not install where the waves can directly radiate into the electrical box, controller cable, or controller. Inverters, appliances, high-frequency medical equipment, and radio communications equipment may cause the unit to malfunction. The operation of the unit may also adversely affect these same devices. Install the unit at least 10 ft. (approximately 3m) away from such devices.
- Locate the wireless controller at a distance of at least three feet (approximately 1m) between the indoor unit and electric lighting. Otherwise, the receiver part of the unit may have difficulty receiving operation commands.

- If the wired controller is installed in a location where electromagnetic radiation is generated, make sure that the wired controller is shielded and cables are sleeved inside conduit tubing.
- If there is a source of electrical interference near the power source, install noise suppression equipment (filter).
- During the test run, check the unit's operation temperature. If the unit is used in an environment where the temperature exceeds the operation boundary, it may cause severe damage. Check the operation temperature boundary in the manual. If there is no specified temperature, use the unit within the operation temperature boundary of 35° to 104°F (0 to 40°C).
- Read installation and appropriate user manuals for connection with PC or peripheral devices. If a warning window appears on the PC, the product stops, does not work properly or works intermittently, immediately stop using the equipment.

Installation Precautions



Take the following precautions to reduce the risk of electric shock, fire or explosion resulting in serious injury or death:

- If the remote sensors are not used with this controller, then do not install this controller...
 - In a room where there is no thermostat.
 - Where the unit is exposed to direct sunshine or direct light.
 - Where the unit will be in close proximity to a heat source.
 - Where hot/cold air from the outdoors, or a draft from elsewhere (such as air vents, diffusers or grilles) can affect air circulation.
 - In areas with poor air circulation and ventilation.
- Perform a test run using the controller to ensure normal operation. Safety guards, shields, barriers, covers, and protective devices must be in place while the compressor/unit is operating. During the test run, keep fingers and clothing away from any moving parts.

After installation work for the system has been completed, explain the "Safety Precautions," use, and maintenance of the unit to the customer according to the information in all manuals that accompanied the system. All manuals and warranty information must be given to the user or left near the Indoor Unit.

Electrical Precautions



Take the following precautions to reduce the risk of electric shock, fire or explosion resulting in serious injury or death:

- Only use electrical protection equipment and tools suited for this installation.
- Insulate the wired controller against moisture and temperature extremes.
- Use specified cables between units and the controller.
- Communication cabling shall be a minimum of 18-Gauge, 2-Conductor, Stranded Copper. Shielded cable must be considered for applications and routing in areas of high EMI and other sources of potentially excessive electrical noise to reduce the potential for communication errors. When shielded cabling is applied, proper bonding and termination of the cable shield is required as per Johnson Controls guidelines. Plenum and riser ratings for communication cables must be considered per application and local code requirements.
- The polarity of the input terminals is important, so be sure to match the polarity when using contacts that have polarity.
- Highly dangerous electrical voltages may be used in this system. Carefully refer to the wiring diagram and these instructions when wiring. Improper connections and inadequate grounding can cause serious injury or death.
- Before installing the controller or remote devices, ensure that the indoor and outdoor unit operation has been stopped. Further, be sure to wait at least five minutes before turning off the main power switch to the indoor or outdoor units. Otherwise, water leakage or electrical breakdown may result.
- Do not open the service cover or access panel to the indoor or outdoor units without turning OFF the main power supply. Before connecting or servicing the controller or cables to indoor or outdoor units, open and tag all disconnect switches. Never assume electrical power is disconnected. Check with a meter and equipment.

- Use an exclusive power supply at the controller's rated voltage.
- Be sure to install circuit breakers (ground fault interrupter, isolating switch, molded case circuit breaker, and so forth) with the specified capacity. Ensure that the wiring terminals are tightened securely to recommended torque specifications.
- Clamp electrical wires securely with a cord clamp after all wiring is connected to the terminal block. In addition, run wires securely through the wiring access channel.
- When installing the power lines, do not apply tension to the cables. Secure the suspended cables at regular intervals, but not too tightly.
- Make sure that the terminals do not come into contact with the surface of the electrical box. If the terminals are too close to the surface, it may lead to failures at the terminal connection.
- Do not clean with, or pour water into, the controller as it could cause electric shock and/or damage the unit. Do not use strong detergent such as a solvent. Clean with a soft cloth.
- Check that the ground wire is securely connected. Do not connect ground wiring to gas piping, water piping, lighting conductor, or telephone ground wiring.

WARNING

- Do not turn ON the power source, unless the preparations for the test run are completed.

NOTICE

- Read this manual together with the installation and maintenance manual of the indoor unit.

Brand Label

NOTE: Either the York or the Hitachi logo label, but not both, will be shipped with the unit.

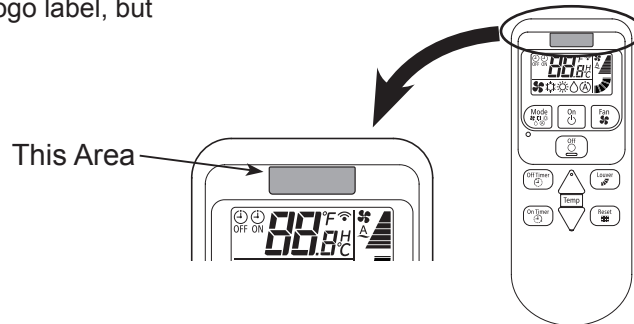

1. Before Installation and Operation

This packing contains the following parts. Check the contents and the number of the parts.

Name	Qty.	Remark
Wireless Controller	1	For Operation Control
Holding Bracket	1	For Controller
Battery (AAA/ 1.5V Dry Cell)	2	For Power Source of Controller
Screw	2	For Fixing "Holding Bracket" onto Wall
Brand Label	1	HITACHI, YORK

2. Setting Batteries

Set the batteries (AAA/1.5V × 2) for the controller as follows.

- Remove the battery cover by sliding it toward the arrow direction part of the cover as shown at right.
- Set the batteries. (Insert the batteries according to the marks of + and - on the case.)

ATTENTION:

Do not press the "On" and "On Timer" switches until the preparation for the Test Run is completed.

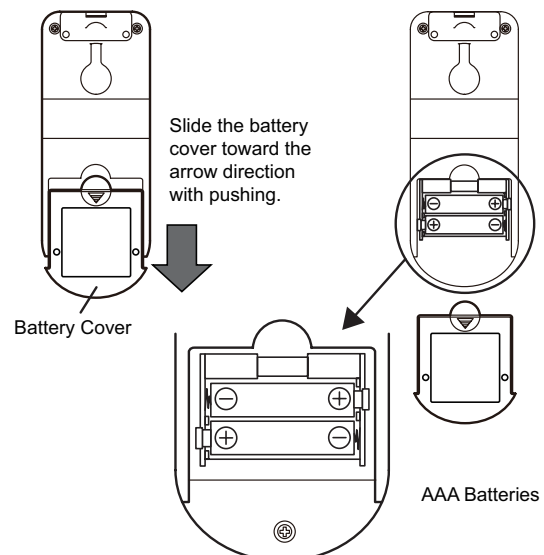

3. Name of Parts

Controller:

- This controller is used to send commands about the operation mode and timer settings for the indoor unit. Point the transmitter of the controller toward the receiver of the indoor unit and press the button for the required operation so that commands (by infrared beam) are sent to the indoor unit.
- The distance for transmitting is approximately 20 feet (6 meters), maximum. (The capable distance for transmitting will get shorter if the angle of transmission is not vertical to the receiver or an electronic type light is used in the room.)
- Use the combination of the receiver kit and the indoor unit which are supported by this controller.

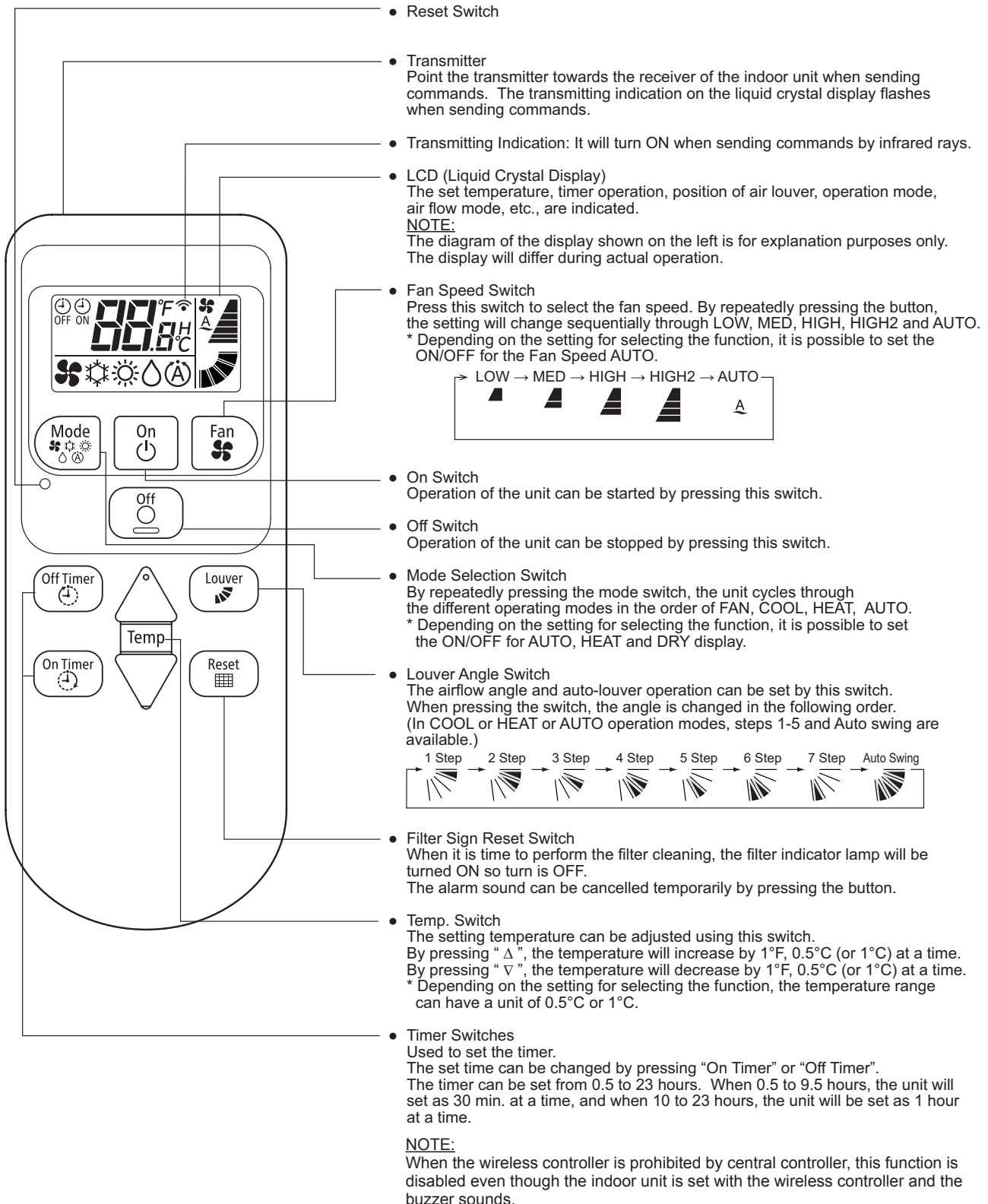

4. Installation Method

When installing the wireless controller onto a wall or a pillar, fix firmly the holding bracket onto the wall and attach the controller where the receiver can receive the commands.

ATTENTION:

Maintain a distance more than 12 inches (31 cm) away from power cables.

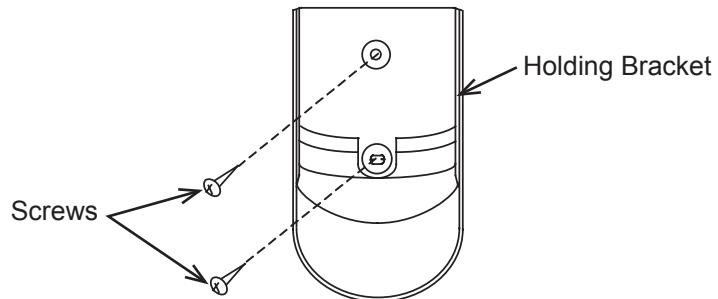

5. Sending Commands from Controller

The operation commands are sent by pressing each button facing the transmitter of the controller toward the receiver of the receiver kit.

1. When the commands are sent, the indication “” on the LCD of the controller flashes once.
2. When the receiver kit receives the commands, the indication light (yellow) on the receiver kit turns ON for an instant, and the buzzer sounds.

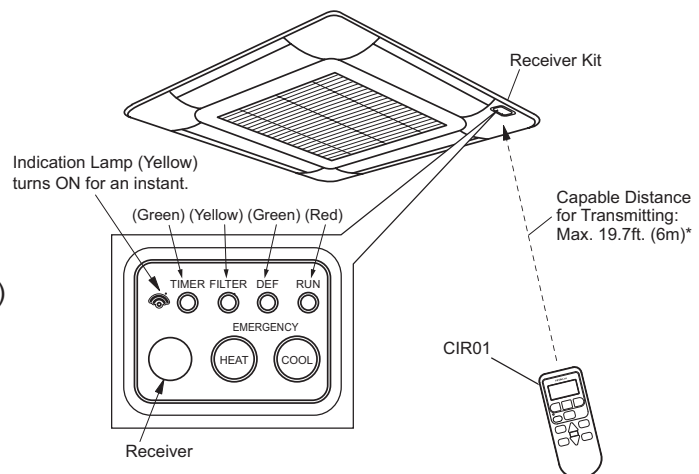

ATTENTION:

* The capable distance for transmitting using the wireless remote controller is maximum 20 feet (6 meters). (The distance may differ depending on the type of a receiver. Check the receiver kit, or refer to the Operation Manual supplied with the indoor unit.) The distance will get shorter if the angle of transmission is not vertical to the receiver or an electronic type light is used in the room.

Liquid Crystal Display (LCD) Indication

When viewed from certain angles, the LCD can be difficult to read. The viewing angle will range from an optimal angle of 60° down to 30°, as shown in the diagram at right. If the viewing angle is below 30°, those readings not displayed appear slightly faded so that it makes for a difficult read. It is a mechanical fault with of this LCD, which is not considered an irregularity.

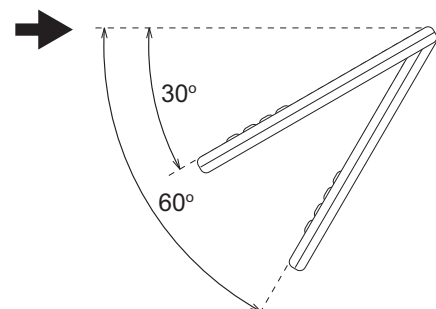

6. Optional Function Setting

The display range of the wireless controller can be set, following the function to set the indoor unit.

ATTENTION:

The settings cannot operate correctly even if the functions which cannot set the indoor unit, are set with the wireless controller. Concerning the functions which can set the indoor unit, refer to the operation manual of the indoor unit.

Buttons		“ ⏻ On” Buttons	
	1	Operation Mode “AUTO”	Display / <u>Non-display</u>
	2	Operation Mode “HEAT”	<u>Display</u> / Non-display
	3	Operation Mode “DRY”	<u>Display</u> / Non-display
	4	Temperature Setting	°C / <u>°F</u>
	5	Celsius Scale	1°C / <u>0.5°C</u>
	6	Fan Speed Levels	3 steps / <u>4 steps</u> / 6 steps
	7	Fan Speed “AUTO”	<u>Display</u> / Non-display

NOTE: The selected items are set when restoring settings.

Press the “ ○ Off” switch to exit the function selection.

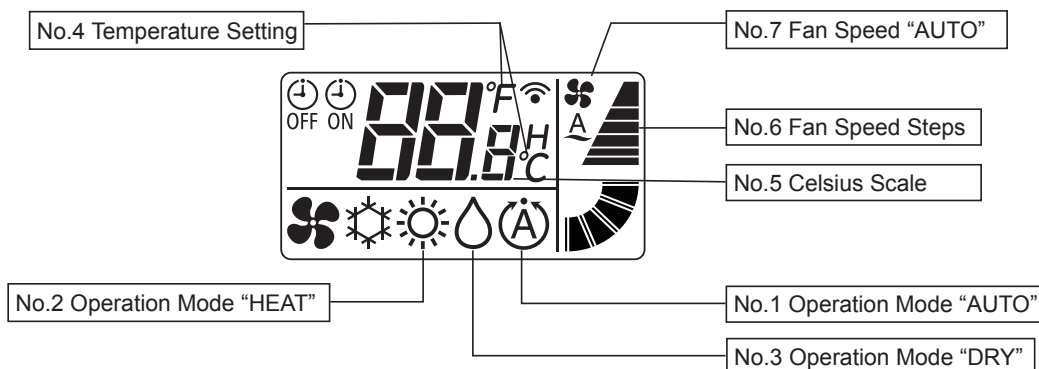

■ Optional Function Setting Procedure

1. Press both “Off Timer” and “Filter Sign Reset” for three seconds.

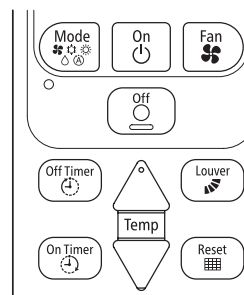

2. If the current setting is “Non-display”, the selected item will flash 0.5 seconds, then it will turn OFF. If the setting is “Display”, it will light continuously.
3. The setting content “Display” or “Non-display” can be changed by pressing the “ ⏻ On” button.
4. Press “▽” to change the item number in ascending order. (No. $\geq 1 \rightarrow 2 \rightarrow 3 \dots 7 \square$)
Press “Δ” to change the item number in descending order. (No. $\geq 1 \rightarrow 7 \rightarrow 6 \dots 2 \square$)
5. Select the item number with “▽” or “Δ”, change the setting content by pressing “ ⏻ On” button and finally exit the optional function setting by pressing the “ ○ Off” button to perform the reset.

NOTES:

1. The optional function setting will automatically end and reset if no operation is performed within 60 seconds after it is displayed.
2. The setting will be recorded each time the “ ⏻ On” button is pressed.

7. Identifying Indoor Units Installed Side by Side Operation

- Purpose

This function is used when operating several receivers or indoor units side by side, to prevent a malfunction because of receiving incorrect signals from the wireless remote controllers used in other areas.

Only the communication between the paired setting is possible, and four pairs (A, B, C, D) are available. For example, the receiver designated "A" can only receive signals from the wireless controller designated as "A". It cannot receive signals from a wireless controller set as B, C or D.

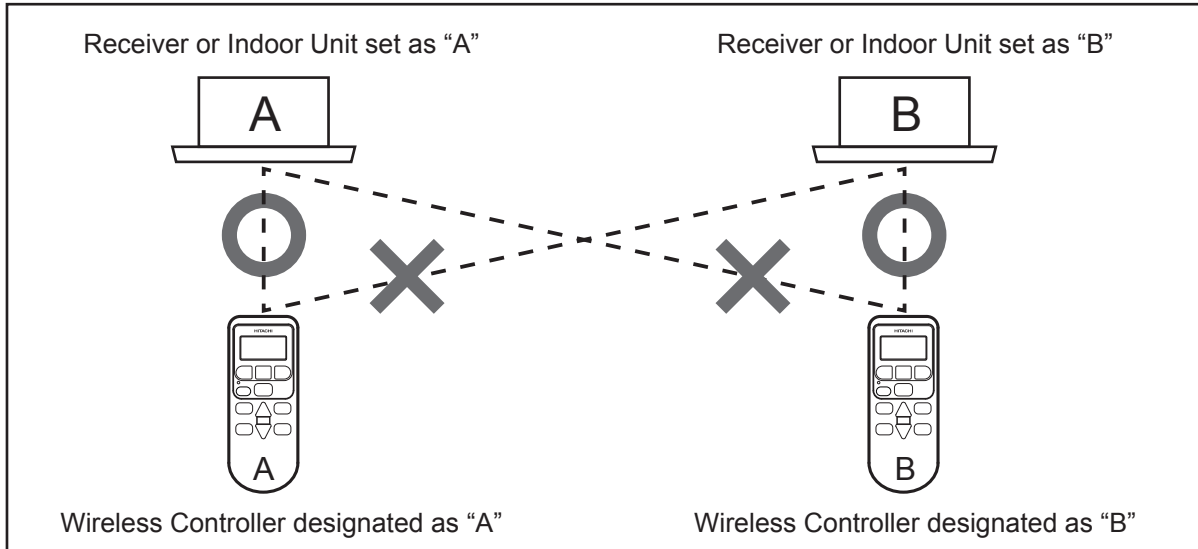

Refer to the installation and maintenance or the Operation Manual for each receiver kit or indoor unit setting. Depending on the type of the receiver kit or the indoor unit, only settings A, and B are available and not C or D. In that case, set the wireless controller as A or B also.

- Procedures for this function

1. Press both "On Timer" and "Filter Sign Reset" for three seconds.
2. The current value set for this function will be displayed (A, B, C or D).



A Mode (A)

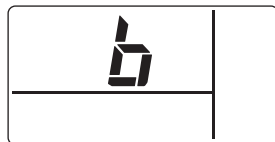

B Mode (b)

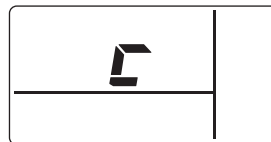

C Mode (c)

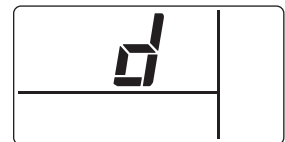

D Mode (d)

3. Press "∇" to change the setting in ascending order. ($\Rightarrow A \rightarrow B \rightarrow C \rightarrow D \Leftarrow$)
Press "Δ" to change the setting in descending order. ($\Leftarrow A \leftarrow B \leftarrow C \leftarrow D \Leftarrow$)

NOTE:

The setting will be recorded each time "⏻ On" switch is pressed.

4. Press the "○ Off" button to exit this function and reset.

NOTE:

If no operation is performed for 30 seconds after this function is displayed, it will automatically end and reset.

8. Test Run with the Controller



- Turn ON the power supply for the indoor units.
The “” light (yellow) on the receiver kit of the indoor unit flashes (0.25 seconds ON ↔ 0.25 seconds OFF), and then turns OFF. While the light is flashing, the unit will not operate because it is initializing.
- Set the Test Run mode by pressing the “Louver” button and “On Timer” button for three seconds at OFF. The LCD will display as shown at right.
- Set the operation mode by pressing the “Mode” button.



Test Run timer mode.



Unit is running under Test mode.

- Operate the Test Run by pressing the “ On” button. When the commands are received by the indoor unit, the “” light (yellow) of the receiver kit will come on briefly. Check that commands are received well and the operation mode selected in item number three above) is set correctly. In the Test Run mode, the red light (RUN) on the receiver kit is turned ON and the green light (TIMER) flashes (0.5 seconds ON ↔ 0.5 seconds OFF). Then set the OFF timer for two hours.
- Adjust the angle of the air louver as follows.
Verify that commands are received correctly by using the light and buzzer of the receiver kit. Use the wireless remote controller pointing the transmitter toward the receiver.

ATTENTION:

The air louver has a control mechanism for the auto-swing function. Do not attempt to manually move the louver by force.

- Select the FAN mode by pressing the “Mode” switch.
- Set the louver angle by pressing the “Louver” switch.
The louver direction is changed as follows.

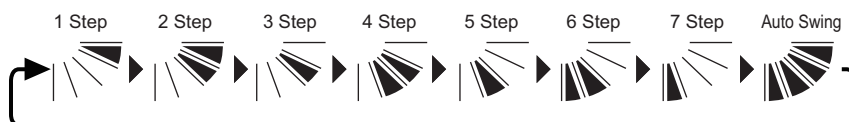

- Halt the Test Run.
 - Test Run is halted automatically after two hours.
 - Test Run is halted by pressing “ OFF” button.
After Test Run is finished, check that the red light (RUN) and the green light (TIMER) are turned OFF.

About FCC Rules.

This device complies with part 15 of the FCC Rules. Operation is subject to the following two conditions: (1) This device may not cause harmful interference, and (2) this device must accept any interference received, including interference that may cause undesired operation.