

Installation Manual for Infrared (IR) Receiver Kit (for 1-Way Cassette Type)

Model	C1IRK01
Applicable Indoor Unit Model	1-Way Cassette Type
Applicable Wireless Controller	CIR01

IMPORTANT:

READ AND UNDERSTAND THIS MANUAL BEFORE USING THIS INFRARED (IR) RECEIVER KIT.
KEEP THIS MANUAL FOR FUTURE REFERENCE.

Important Notice



- Johnson Controls Inc. pursues a policy of continuing improvement in design and performance in its products.
As such, Johnson Controls Inc. reserves the right to make changes at any time without prior notice.
- Johnson Controls Inc. cannot anticipate every possible circumstance that might involve a potential hazard.
- This heat pump air conditioning unit is designed for standard air conditioning applications only. Do not use this unit for anything other than the purposes for which it was intended for.
- The installer and system specialist shall safeguard against leakage in accordance with local pipefitter and electrical codes. The following standards may be applicable, if local regulations are not available. International Organization for Standardization: (ISO 5149 or European Standard, EN 378). No part of this manual may be reproduced in any way without the expressed written consent of Johnson Controls Inc. or York.
- This heat pump air conditioning unit will be operated and serviced in the United States of America and comes with a full complement of the appropriate Safety, Danger, and Caution, Warnings.
- If you have questions, please contact your distributor or dealer.
- This manual provides common descriptions, basic and advanced information to maintain and service this heat pump air conditioning unit which you operate as well for other models.
- This manual should be considered as a permanent part of the air conditioning equipment and should remain with the air conditioning equipment.

Product Inspection upon Arrival

1. Upon receiving this product, inspect it for any damages incurred in transit. Claims for damage, either apparent or concealed, should be filed immediately with the shipping company.
2. Check the model number, electrical characteristics (power supply, voltage, and frequency rating), and any accessories to determine if they agree with the purchase order.
3. The standard utilization for this unit is explained in these instructions. Use of this equipment for purposes other than what it designed for is not recommended.
4. Please contact your local agent or contractor as any issues involving installation, performance, or maintenance arise. Liability does not cover defects originating from unauthorized modifications performed by a customer without the written consent of Johnson Controls, Inc. and York. Performing any mechanical alterations on this product without the consent of the manufacturer will render your warranty null and void.

1. Safety Summary

Signal Words

 WARNING	Indicates a hazardous situation that, if not avoided, could result in death or serious injury.
 CAUTION	Indicates a hazardous situation that, if not avoided, could result in minor or moderate injury.
NOTICE	Indicates information considered important, but not hazard-related (for example, messages relating to property damage).

General Precautions

 WARNING	To reduce the risk of serious injury or death, read these instructions thoroughly and follow all warnings or cautions included in all manuals that accompanied the product and are attached to the unit. <i>Refer back to these safety instructions as needed.</i>
--	---

- This system, should be installed by personnel certified by Johnson Controls, Inc. Personnel must be qualified according to local, state and national building and safety codes and regulations. Incorrect installation could cause leaks, electric shock, fire or an explosion. In areas where Seismic Performance requirements are specified, the appropriate measures should be taken during installation to guard against possible damage or injury that might occur in an earthquake. If the unit is not installed appropriately correctly, injuries may occur because of a falling unit.
- Use appropriate Personal Protective Equipment (PPE), such as gloves, protective goggles and electrical protection equipment and tools suited for electrical operation purposes.
- When transporting, be careful when picking up, moving and mounting these units. Although the controller may be packed using plastic straps, do not use them for transporting from one location to another. Do not stand on or put any material on the controller.
- When installing the controller cabling to the units, do not touch or adjust any safety devices inside the indoor or outdoor units. All safety features, disengagement, and interlocks must be in place and functioning correctly before the equipment is put into operation. If these devices are improperly adjusted or tampered with in any way, a serious accident can occur. Never bypass, wire around, or jump-out any safety device or switch.
- Use only Johnson Controls recommended, provided as standardized, or replacement parts.
- Johnson Controls shall will not assume any liability for injuries or damage caused by not following steps outlined or described in this manual. Unauthorized modifications to Johnson Controls products are prohibited as they...
 - May create hazards which could result in death, serious injury or equipment damage;
 - Will void product warranties;
 - May invalidate product regulatory certifications;
 - May violate OSHA standards;

NOTICE

Take the following precautions to reduce the risk of property damage.

- Do not touch the main circuit board or electronic components in the controller or remote devices. Make sure that dust and/or steam does not accumulate on the circuit board.
- When installing the unit in a hospital or other facility where electromagnetic waves are generated from nearby medical and/or electronic devices, be prepared for noise and electronic interference Electromagnetic Interference (EMI). Do not install where the waves can directly radiate into the electrical box, controller cable, or controller. Inverters, appliances, high-frequency medical equipment, and radio communications equipment may cause the unit to malfunction. The operation of the unit may also adversely affect these same devices. Install the unit at least 10 ft. (approximately 3m) away from such devices.
- Locate the controller at a distance of at least 3 ft. (approximately 1m) between the indoor unit and electric lighting. Otherwise, the receiver part of the unit may have difficulty receiving operation commands.
- If the controller is installed in a location where electromagnetic radiation is generated, make sure that the controller is shielded and cables are sleeved inside conduit tubing.
- If there is a source of electrical interference near the power source, install noise suppression equipment (filter).
- During the test run, check the unit's operation temperature. If the unit is used in an environment where the temperature exceeds the operation boundary, it may cause severe damage. Check the operation temperature boundary in the manual. If there is no specified temperature, use the unit within the operation temperature boundary of 35 to 104°F (0 to 40°C).
- Read installation and appropriate user manuals for connection with PC or peripheral devices. If a warning window appears on the PC, the product stops, does not work properly or works intermittently, immediately stop using the equipment.

Installation Precautions

⚠ WARNING

Take the following precautions to reduce the risk of electric shock, fire or explosion resulting in serious injury or death:

- Perform a test run using the controller to ensure normal operation. Safety guards, shields, barriers, covers, and protective devices must be in place while the compressor/unit is operating. During the test run, keep fingers and clothing away from any moving parts.

After installation work for the system has been completed, explain the "Safety Precautions," use, and maintenance of the unit to the customer according to the information in all manuals that accompanied the system. All manuals and warranty information must be given to the user or left near the Indoor Unit.

Electrical Precautions



Take the following precautions to reduce the risk of electric shock, fire or explosion resulting in serious injury or death:

- Only use electrical protection equipment and tools suited for this installation.
- Insulate the infrared (IR) receiver kit against moisture and temperature extremes.
- Use specified cables between units and the infrared (IR) receiver kit.
- Communication cabling shall be a minimum of AWG18 (0.82mm²), 2-Conductor, Stranded Copper. Shielded cable must be considered for applications and routing in areas of high EMI and other sources of potentially excessive electrical noise to reduce the potential for communication errors. When shielded cabling is applied, proper bonding and termination of the cable shield is required as per Johnson Controls guidelines. Plenum and riser ratings for communication cables must be considered per application and local code requirements.
- The polarity of the input terminals is important, so be sure to match the polarity when using contacts that have polarity.
- Highly dangerous electrical voltages may be used in this system. Carefully refer to the wiring diagram and these instructions when wiring. Improper connections and inadequate grounding can cause serious injury or death.
- Before installing the infrared (IR) receiver kit, ensure that the indoor and outdoor unit operation has been stopped. Further, be sure to wait at least five minutes before turning off the main power switch to the indoor or outdoor units. Otherwise, water leakage or electrical breakdown may result.
- Do not open the service cover or access panel to the indoor or outdoor units without turning OFF the main power supply. Before connecting or servicing the controller or cables to indoor or outdoor units, open and tag all disconnect switches. Never assume electrical power is disconnected. Check with a meter and equipment.
- Use an exclusive power supply at the controller's rated voltage.
- Be sure to install circuit breakers (ground fault interrupter, isolating switch, molded case circuit breaker, and so forth) with the specified capacity. Ensure that the wiring terminals are tightened securely to recommended torque specifications.
- Clamp electrical wires securely with a cord clamp after all wiring is connected to the terminal block. In addition, run wires securely through the wiring access channel.
- When installing the power lines, do not apply tension to the cables. Secure the suspended cables at regular intervals, but not too tightly.
- Make sure that the terminals do not come into contact with the surface of the electrical box. If the terminals are too close to the surface, it may lead to failures at the terminal connection.
- Do not clean with, or pour water into, the infrared (IR) receiver kit as it could cause electric shock and/or damage the unit. Do not use strong detergent such as a solvent. Clean with a soft cloth.
- Check that the ground wire is securely connected. Do not connect ground wiring to gas piping, water piping, lighting conductor, or telephone ground wiring.

CAUTION



- Do not apply excessive force when removing the plastic cover. Otherwise, it may cause damage to the fixing hooks of the plastic cover, or may result in injury.
- Hold the optional decorative panel securely to prevent it from falling when it is removed. If it falls, there may be panel damage or injury.

NOTICE

- To ensure correct performance, this manual together with the “Installation and Maintenance Manual” for the indoor unit and the wireless controller. Forward this information to the building owner and request that they maintain all the equipment manuals.
- C1IRK01 is only available to be used in combination with the wireless controller CIR01 and the indoor unit 1-way cassette type models.

2. Factory-Supplied Accessories

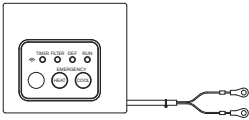
Check to ensure that the following accessories are packed with the IR receiver kit.

No.	Accessory	Qty	Remarks
①	IR Receiver Kit C1IRK01 	1	with Connecting Cable
②	Cable Clamp 	3	for Fixing Cable
③	Plastic Band 	3	for Fixing Cable
④	Installation Manual	1	-
⑤	Operation Manual	1	-

3. Installation

⚠ WARNING

- Turn OFF the power source completely before setting the DIP switch, installation work and electrical wiring work for IR receiver kit.
If not, it may cause an electric shock.
- Perform securely the installation work referring to this installation manual.
If the installation is not completed, it may cause injury by falling down the IR receiver kit.
- Do not install the IR receiver kit where the flammable gases may generate or enter.
It may cause heat generation or a fire.
- Perform securely the electrical wiring work.
If the electrical work is not completed, heat generation at the connection, a fire or an electric shock may occur.
- Make sure that the electrical wires are securely fixed in order not to apply an external force to the terminal connections of the wirings. Not doing so may cause heat generation or a fire.

NOTICE

- When the IR receiver kit is near ambient lighting, it may not receive a signal from the wireless controller. Therefore, pay particular attention to the installation position of the IR receiver kit.
- Do not run the connecting cable for the IR receiver kit and the power source cable (208/230V) in parallel. It may cause a malfunction of the IR receiver kit.
- When the IR receiver kit is installed with the indoor units' installation, start from procedure [3](#).
- When the IR receiver kit is installed after the indoor units' installation, be sure to turn OFF the power source completely before starting installation.

[1](#) Air Inlet Grille Removal

- (1) The air inlet grille can be opened by pushing the knobs of the air inlet grille backward.

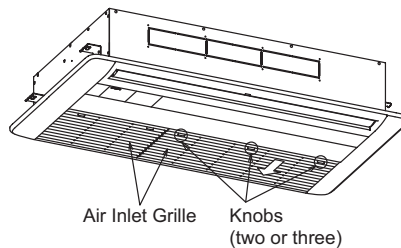

- (2) Remove the hook of the supporting string from the decorative panel.

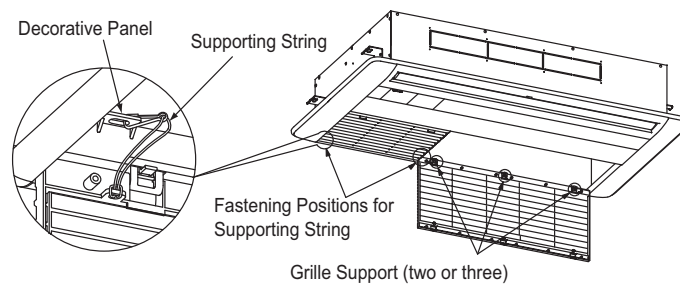

- (3) Open the air inlet grille. The air inlet grille can be removed by pushing the extruded part of the grille in the direction of the arrow, and pulling the air inlet grille downward as shown in the figure at the right.

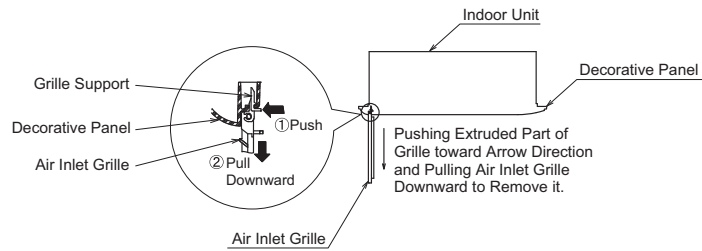

NOTICE

Be careful not to drop the air inlet grille or air filter when removing them.

2 Optional Decorative Panel Removal

Follow the procedures from (1) to (5).

At least two (2) people are required for removing.

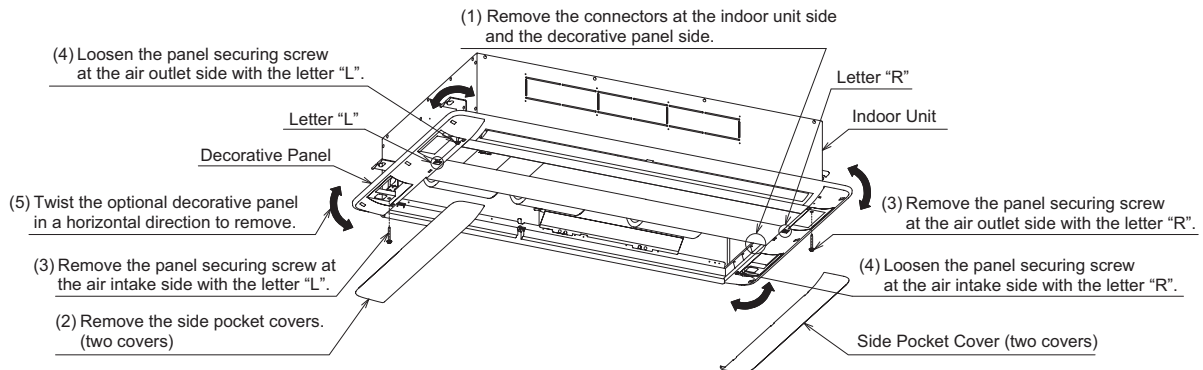

CAUTION

- Do not apply excessive force removing the side pocket covers. Doing so may cause damage of the coupling hooks of the side pocket covers, or may result in injury.
- Hold the decorative panel securely to prevent it from falling when it is removed.

3 Controller Cover Removal

CAUTION

Do not apply excessive force when removing the controller cover. Doing so cause of damage of the coupling hooks of the controller cover, or may result in injury.

Attaching Position of Wireless Controller IR Receiver Kit
(Can be fixed on either right or left side.)

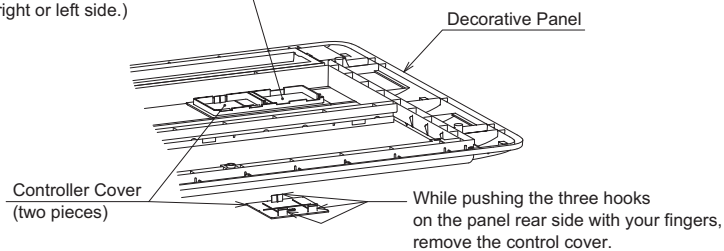

- 4 Follow the procedures from (1) to (3) to attach the IR receiver kit on the decorative panel.

Unit: inch (mm)

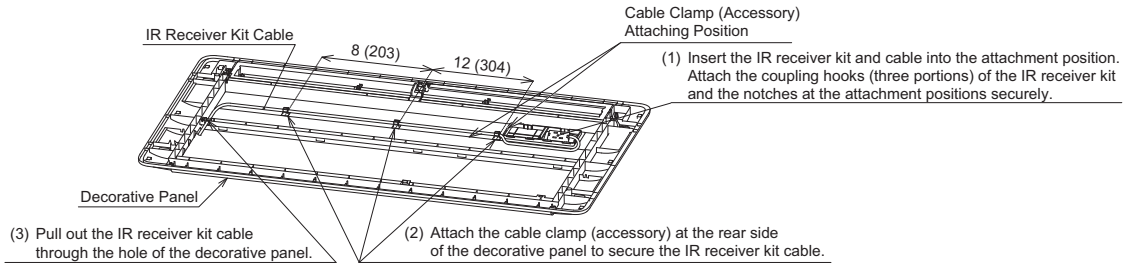

NOTICE

- Pay particular attention to the installation direction of the IR receiver kit. Number of coupling hooks of the IR receiver should match the notches at the installation position.
- Check to ensure that the IR receiver kit is securely installed.
- Be sure to attach the cable clamp (accessory) according to the required position. If not, condensation may occur because of a space between decorative panel and the indoor unit.

- 5 Install the decorative panel to the indoor unit according to the “Installation and Maintenance Manual” for the decorative panel.

- 6 Secure the IR receiver kit cable with the cable clamp of the indoor unit.

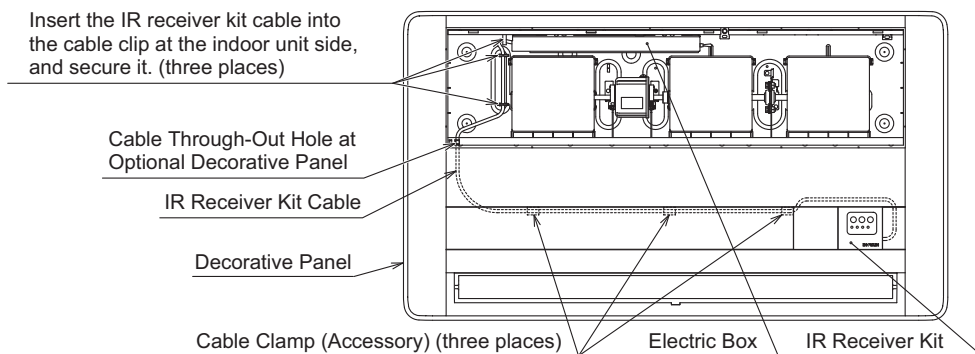

- 7 Remove the electric box cover of the indoor unit. Connect the IR receiver kit cable to the terminal blocks (A, B) in the electric box as shown at the right. (Terminals A and B have no polarity.)

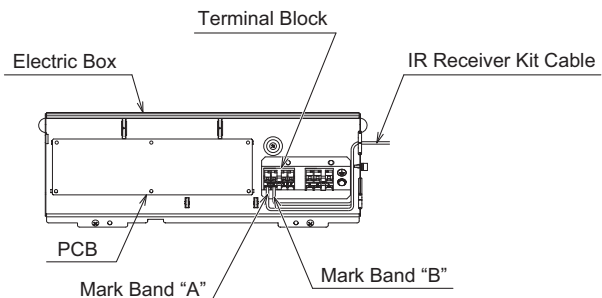

4. Optional Functions

⚠ WARNING

Turn OFF the power source completely before setting the DIP switch for the IR receiver kit. Not doing so may result in an electric shock.

- 1 The following switches are on the IR receiver kit.

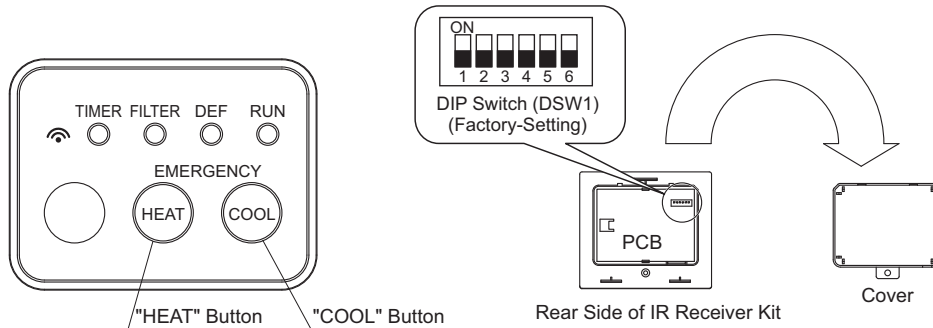

- 2 Emergency Operation Setting

“COOL” and “HEAT” button are used for an emergency operation when the batteries for the wireless controller are low.

- (1) “COOL” Button: Press “COOL” so that the cooling operation is started.
Press “COOL” again so that the cooling operation is stopped.
- (2) “HEAT” Button: Press “HEAT” so that the heating operation is started.
Press “HEAT” again so that the heating operation is stopped.

NOTE:

During an emergency operation, a yellow light “” flashes (0.5 second ON/0.5 second OFF). The temperature set-point and the fan speed for the cooling/heating operation are the same as before starting an emergency operation.

- 3 The DIP switch (DSW1) is for the optional function selection. If the optional function selection is required, set the DIP switch as follows.

Optional Function	DIP Switch Setting (DSW1)						Details
	1	2	3	4	5	6	
Main/Sub Setting	O	X	X	X	X	X	Change main (OFF setting)/ sub (ON setting) wireless controller for a two wireless controller system.
Identification of Indoor Unit	X	O	X	X	X	X	It functions as B Mode (identification of indoor unit) of the wireless controller when it “ON”.
Invalid Emergency Operation	X	X	X	O	X	X	The switches for emergency operation are invalid.

O: ON
X: OFF

NOTICE

Review the following settings when the function for the IR receiver kit is selected from the wireless controller or the centralized controller.

- The cooling lower limit for the temperature set-point and the heating upper limit for temperature set-point are not available. The setting is available beyond the upper and lower limit for temperature set-point from the wireless controller.
- The optional function setting “Fixing of Setting Temperature” is not available. When the operation mode is changed from the wireless controller, the indicated temperature on the wired controller becomes the set temperature of the wireless controller.

5. Identifying Indoor Units Installed for a Side-by-Side Operation

⚠ WARNING

Turn OFF the power source completely before setting the DIP switch for the IR receiver kit. Not doing so may cause an electric shock.

When two indoor units are installed side by side, the commands from the wireless controller may be received by both indoor units. The function, "Identifying of Indoor Units Installed Side by Side" enables operation of the individual unit correctly without interfering with the other unit's operation. As shown in the figure at the right, the indoor units of A and B are set side by side. In this instance, unit B is set as "Identifying Indoor Units Installed Side by Side".

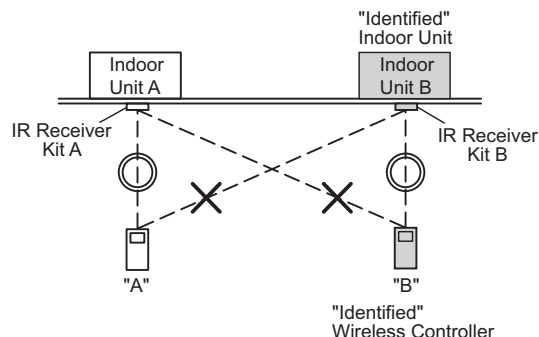

< Setting of Identifying of Indoor Units Installed Side by Side >

- 1 IR Receiver Kit Setting
Set the Number 2 pin of the IR receiver kit DIP switch (DSW1) at the "Identified" Unit B "ON" side.
- 2 Wireless Controller
Set the wireless controller according to the Installation and Maintenance Manual for the Wireless Controller.

< Cancellation of Identifying of Indoor Units Installed Side by Side >

- 1 IR Receiver Kit Setting
Set the Number 2 pin of the IR receiver kit DIP switch (DSW1) "OFF" side for cancellation.
- 2 Wireless Controller
Cancel the wireless controller setting according to the Installation and Maintenance Manual for the Wireless Controller.

5. Simultaneous Operation

Up to 16 indoor units can be simultaneously controlled using one wireless controller. When multiple indoor units are installed in a large room, all the indoor units can be controlled to start/stop with only one wireless controller.

NOTE:

Do not apply a simultaneous operation for indoor units installed separately in different rooms. Some units may be left without turning OFF the power source.

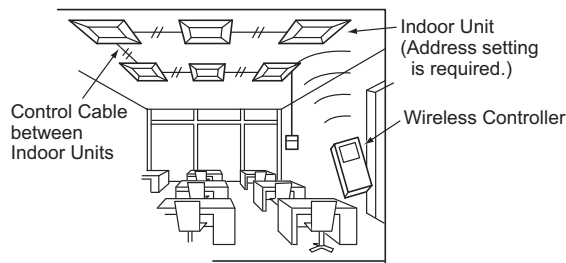

Control Example of Simultaneous Operation of Multiple Units

(The figure represents 4-way cassette type indoor units.)

< Installation of IR Receiver Kit >

In an instance of simultaneous operation of multiple (up to 16) indoor units by the wireless controller, install the IR receiver kit only to the unit to be operated. Other units should be standard units without the IR receiver kit. If multiple IR receiver kits are required be installed, two IR receiver kits are the maximum.

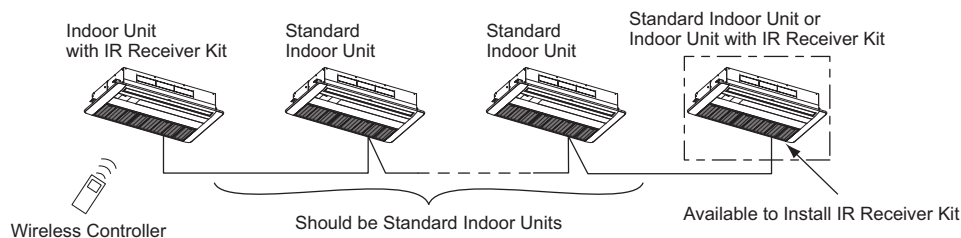

< Electrical Wiring Connecting and Setting >

- 1 Connection between Indoor Units
Perform the connection work as shown below.

< Power Source Cable 208/230V >

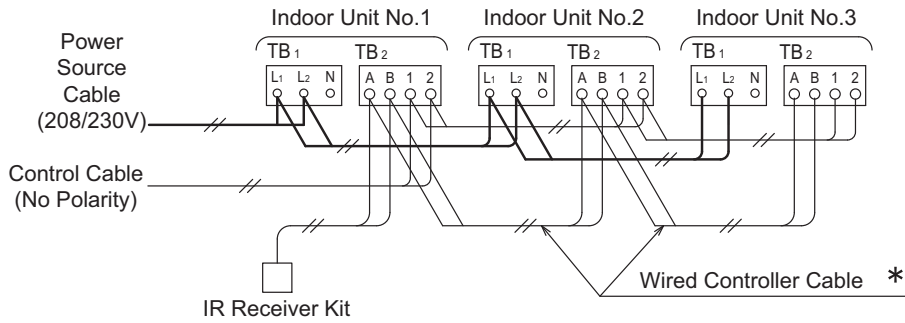

* For twin, triple or quad combinations, a communication cable for the wireless controller is not required.

Use the field-supplied communication cable (AWG18) for the wired controller cable. The total length should be within 1640ft (500m). If the total length is less than 98ft (30m), AWG22 cable can be used.

- 2 Do not run the connected wireless controller cable and the power source cable (208/230V) in parallel in the indoor units.
Stabilize the cable with plastic bands. Along with the wiring outside the indoor units, the control cables should not run with the power source cable (208/230V). Keep a separation of more than 12 inches, or run the cable through a grounded metal conduit and ground the tube end.
- 3 Unit Number Setting
The indoor unit numbers are set by the auto-address function. Therefore, the indoor unit number setting is not required. If the indoor unit number is fixed, set the unit numbers of all indoor units respectively and serially. It is recommended that the unit number settings begin with "1". The setting is set to overlap the unit number.

Unit Number Setting

DSW6 (Tens Digit)	RSW1 (Units Digit)	Ex.: Set for No. 16 Unit
<p>ON OFF</p>	<p>Setting Position</p> <p>Set by inserting slotted screwdriver into the groove.</p>	<p>DSW6</p> <p>ON OFF</p> <p>Set No.1 pin ON.</p> <p>RSW1</p> <p>Set at "6".</p>
<p>Factory setting for DSW6 and RSW1 were set to "0". Max. 63 units are available for setting.</p>		

7. Test Run for Wireless Controller (CIR01)

After all installations are completed, a test run should be performed.

- (1) Perform the test run according to the installation manual for the wireless controller.
- (2) The test run for the wireless controller will take two hours to complete. If the TIMER indicator (green) is flashing (0.5 second ON/0.5 second OFF) after two hours, an alarm may occur. Operate the indoor unit and check for abnormality.

8. Alarm Indication

NOTICE

- If a malfunction occurs such as a safety device actuation during the test run or the normal operation, "RUN" (red light) flashes (0.5 second ON/0.5 second OFF).
- The alarm codes are indicated by the flashing of "DEF" (green light) and "FILTER" (yellow light).
The first LED light is green. The number of times this LED flashes (0.5 second ON and OFF) will tell you the "DEF" Alarm Code.
The second LED light is yellow. The number of times this LED flashes (0.5 second ON and OFF) will tell you the "FILTER" Alarm Code.

< Example >

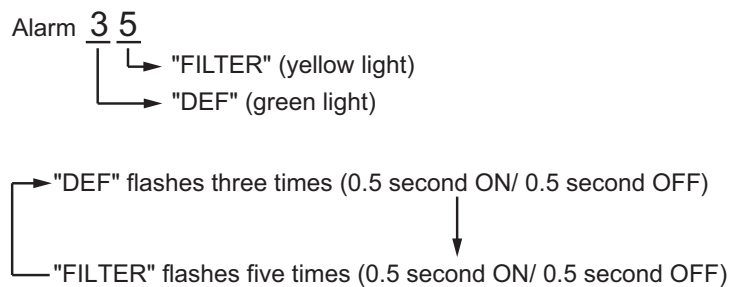

These signals are repeated until the alarm is reset.

- "RUN" (red light) flashing (1 second ON / 1 second OFF) indicates the abnormal transmitting (connector loose, connector disconnection, broken wire or incorrect wiring, or something similar) between the indoor unit and the IR receiver kit.
- When the IR receiver kit is connected to multiple indoor units, the alarm code is indicated for each indoor unit in order.

< Alarm Code Table >

Further details for alarm codes can be found in the "Installation and Maintenance Manual" for the indoor unit.