

Operation Manual

- CWDIRK01 -

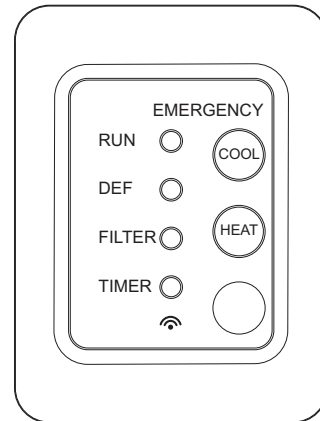

IMPORTANT:

*READ AND UNDERSTAND
THIS MANUAL BEFORE
USING THIS IR RECEIVER KIT.
KEEP THIS MANUAL FOR
FUTURE REFERENCE.*



P5415465

TABLE OF CONTENTS

1. Safety Summary	1
2. Before Operation.....	4
2.1 Efficient Use of Indoor Unit.....	4
2.2 Efficient Use of Cooling and Heating.....	4
2.3 Names of Parts and Indications for Safety Considerations	4
2.3.1 Receiver Kit (CWDIRK01)	4
2.3.2 Wireless Controller	5
2.4 Handling Wireless Controller.....	6
2.4.1 Sending Commands from Wireless Controller.....	6
2.4.2 Horizontal Distance Limit for Receiver Kit	6
2.4.3 Receipt Confirmation of IR Receiver Kit	7
3. Operation	8
3.1 Basic Operation.....	8
3.2 Operation Mode (Cooling, Heating, Dry, Fan, and Automatic Cooling/Heating Operation).....	9
3.3 Setting Method	9
3.3.1 Temperature Setting	9
3.3.2 Fan Speed	10
3.3.3 Airflow Direction.....	10
3.4 Automatic Cooling/Heating Operation	11
3.5 Timer Setting Method	12
3.6 Emergency Operation	13
3.7 Identifying Indoor Units Installed Side by Side	13
3.8 Simultaneous Operation of Multiple Indoor Units	13
3.9 Operation with Wired Controller	14
3.10 Automatic Operation.....	14
4. Maintenance	14
4.1 Cleaning Wireless Controller.....	14
4.2 Replacing Batteries	14
5. Indications of IR Receiver Kit.....	15
5.1 In Normal Condition.....	15
5.1.1 Defrost	15
5.1.2 Filter Sign.....	15
5.1.3 Central Control.....	15
5.2 In Abnormal Condition	16
5.2.1 Abnormality.....	16
5.2.2 Power Failure.....	16
5.2.3 Electromagnetic Interference (EMI).....	16
6. Troubleshooting	17
6.1 This is Not Abnormal	17
6.2 Before Contact	17
6.3 Contact Distributor.....	18

1. Safety Summary

Signal Words

 WARNING	Indicates a hazardous situation that, if not avoided, could result in death or serious injury.
 CAUTION	Indicates a hazardous situation that, if not avoided, could result in minor or moderate injury.
NOTICE	Indicates information considered important, but not hazard-related (for example, messages relating to property damage).

General Precautions

 WARNING	To reduce the risk of serious injury or death, read these instructions thoroughly and follow all warnings or cautions included in all manuals that accompanied the product and are attached to the unit. <i>Refer back to these safety instructions as needed.</i>
--	---

- This system, should be installed by personnel certified by Johnson Controls, Inc. Personnel must be qualified according to local, state and national building and safety codes and regulations. Incorrect installation could cause leaks, electric shock, fire or an explosion. In areas where Seismic Performance requirements are specified, the appropriate measures should be taken during installation to guard against possible damage or injury that might occur in an earthquake. If the unit is not installed appropriately correctly, injuries may occur because of a falling unit.
- Use appropriate Personal Protective Equipment (PPE), such as gloves, protective goggles and electrical protection equipment and tools suited for electrical operation purposes.
- When transporting, be careful when picking up, moving and mounting these units. Although the controller may be packed using plastic straps, do not use them for transporting from one location to another. Do not stand on or put any material on the controller.
- When installing the controller cabling to the units, do not touch or adjust any safety devices inside the indoor or outdoor units. All safety features, disengagement, and interlocks must be in place and functioning correctly before the equipment is put into operation. If these devices are improperly adjusted or tampered with in any way, a serious accident can occur. Never bypass, wire around, or jump-out any safety device or switch.
- Use only Johnson Controls recommended, provided as standardized, or replacement parts.
- Johnson Controls shall will not assume any liability for injuries or damage caused by not following steps outlined or described in this manual. Unauthorized modifications to Johnson Controls products are prohibited as they...
 - May create hazards which could result in death, serious injury or equipment damage;
 - Will void product warranties;
 - May invalidate product regulatory certifications;
 - May violate OSHA standards;

NOTICE

Take the following precautions to reduce the risk of property damage.

- Do not touch the main circuit board or electronic components in the controller or remote devices. Make sure that dust and/or steam does not accumulate on the circuit board.
- When installing the unit in a hospital or other facility where electromagnetic waves are generated from nearby medical and/or electronic devices, be prepared for noise and electronic interference Electromagnetic Interference (EMI). Do not install where the waves can directly radiate into the electrical box, controller cable, or controller. Inverters, appliances, high-frequency medical equipment, and radio communications equipment may cause the unit to malfunction. The operation of the unit may also adversely affect these same devices. Install the unit at least 10 ft. (approximately 3m) away from such devices.
- Locate the controller at a distance of at least 3 ft. (approximately 1m) between the indoor unit and electric lighting. Otherwise, the receiver part of the unit may have difficulty receiving operation commands.
- If the controller is installed in a location where electromagnetic radiation is generated, make sure that the controller is shielded and cables are sleeved inside conduit tubing.
- If there is a source of electrical interference near the power source, install noise suppression equipment (filter).
- During the test run, check the unit's operation temperature. If the unit is used in an environment where the temperature exceeds the operation boundary, it may cause severe damage. Check the operation temperature boundary in the manual. If there is no specified temperature, use the unit within the operation temperature boundary of 35 to 104°F (0 to 40°C).
- Read installation and appropriate user manuals for connection with PC or peripheral devices. If a warning window appears on the PC, the product stops, does not work properly or works intermittently, immediately stop using the equipment.

Installation Precautions

⚠ WARNING

Take the following precautions to reduce the risk of electric shock, fire or explosion resulting in serious injury or death:

- Perform a test run using the controller to ensure normal operation. Safety guards, shields, barriers, covers, and protective devices must be in place while the compressor/unit is operating. During the test run, keep fingers and clothing away from any moving parts.

After installation work for the system has been completed, explain the "Safety Precautions," use, and maintenance of the unit to the customer according to the information in all manuals that accompanied the system. All manuals and warranty information must be given to the user or left near the Indoor Unit.

Electrical Precautions



WARNING

Take the following precautions to reduce the risk of electric shock, fire or explosion resulting in serious injury or death:

- Only use electrical protection equipment and tools suited for this installation.
- Insulate the infrared (IR) receiver kit against moisture and temperature extremes.
- Use specified cables between units and the infrared (IR) receiver kit.
- Communication cabling shall be a minimum of AWG18 (0.82mm²), 2-Conductor, Stranded Copper. Shielded cable must be considered for applications and routing in areas of high EMI and other sources of potentially excessive electrical noise to reduce the potential for communication errors. When shielded cabling is applied, proper bonding and termination of the cable shield is required as per Johnson Controls guidelines. Plenum and riser ratings for communication cables must be considered per application and local code requirements.
- The polarity of the input terminals is important, so be sure to match the polarity when using contacts that have polarity.
- Highly dangerous electrical voltages may be used in this system. Carefully refer to the wiring diagram and these instructions when wiring. Improper connections and inadequate grounding can cause serious injury or death.
- Before installing the infrared (IR) receiver kit, ensure that the indoor and outdoor unit operation has been stopped. Further, be sure to wait at least five minutes before turning off the main power switch to the indoor or outdoor units. Otherwise, water leakage or electrical breakdown may result.
- Do not open the service cover or access panel to the indoor or outdoor units without turning OFF the main power supply. Before connecting or servicing the controller or cables to indoor or outdoor units, open and tag all disconnect switches. Never assume electrical power is disconnected. Check with a meter and equipment.
- Use an exclusive power supply at the controller's rated voltage.
- Be sure to install circuit breakers (ground fault interrupter, isolating switch, molded case circuit breaker, and so forth) with the specified capacity. Ensure that the wiring terminals are tightened securely to recommended torque specifications.
- Clamp electrical wires securely with a cord clamp after all wiring is connected to the terminal block. In addition, run wires securely through the wiring access channel.
- When installing the power lines, do not apply tension to the cables. Secure the suspended cables at regular intervals, but not too tightly.
- Make sure that the terminals do not come into contact with the surface of the electrical box. If the terminals are too close to the surface, it may lead to failures at the terminal connection.
- Do not clean with, or pour water into, the infrared (IR) receiver kit as it could cause electric shock and/or damage the unit. Do not use strong detergent such as a solvent. Clean with a soft cloth.
- Check that the ground wire is securely connected. Do not connect ground wiring to gas piping, water piping, lighting conductor, or telephone ground wiring.

NOTICE

The wireless controller shall be utilized under the following conditions.
If not, it may cause failure of wireless controller.

Installation Place: Indoor

Ambient Temperature: 41 to 95°F (5 to 35°C)

Ambient Humidity: 35 to 90%

2. Before Operation

For details about operation procedures for the air conditioner, refer to the operation manual for each indoor unit.

2.1 Efficient Use of Indoor Unit

Refer to the operation manual for each indoor unit.

2.2 Efficient Use of Cooling and Heating

Refer to the operation manual for each indoor unit.

2.3 Names of Parts and Indications for Safety Considerations

Safety considerations are located on the indoor unit.

Read and understand this manual before using the IR receiver kit.

2.3.1 Receiver Kit (CWDIRK01)

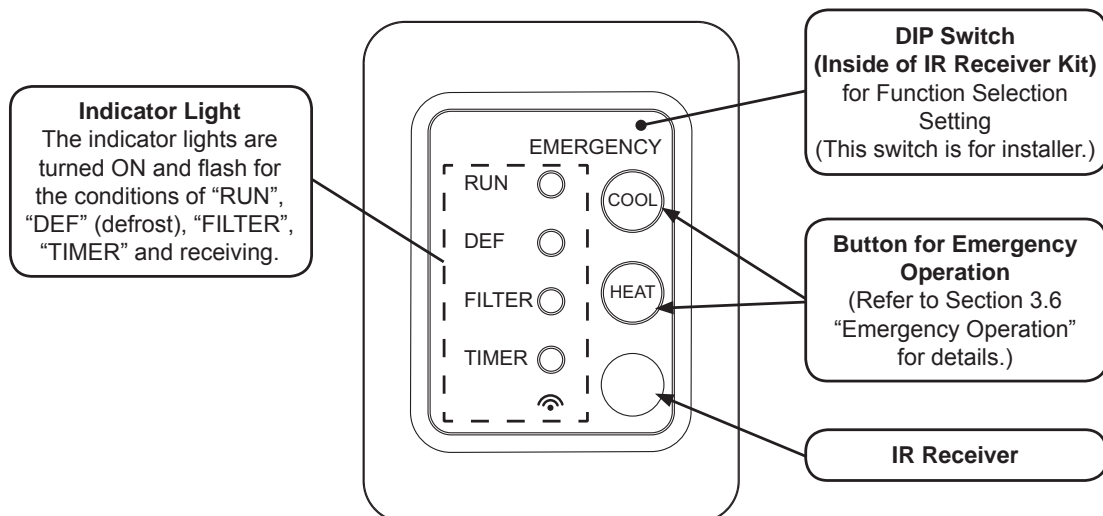

2.3.2 Wireless Controller
Model: CIR01

NOTE

- This wireless controller is used to send commands relating to the operation mode, timer settings, and so forth, to the indoor unit. Point the transmitter of the controller toward the receiver of the indoor unit and press the button of the required operation so that commands (by infrared rays) are sent to the indoor unit.
- The distance for transmitting is approximately 20 feet as a maximum. Refer to Section 2.4.2 “Horizontal Distance Limit for IR Receiver Kit” for details. (A suitable distance for transmission will be shorter if the transmitting angle is not vertical to the receiver or an electronic type light is used in the room.)
- CIR01 is only available paired with the IR receiver kit and the indoor unit which are supported in High2 mode.

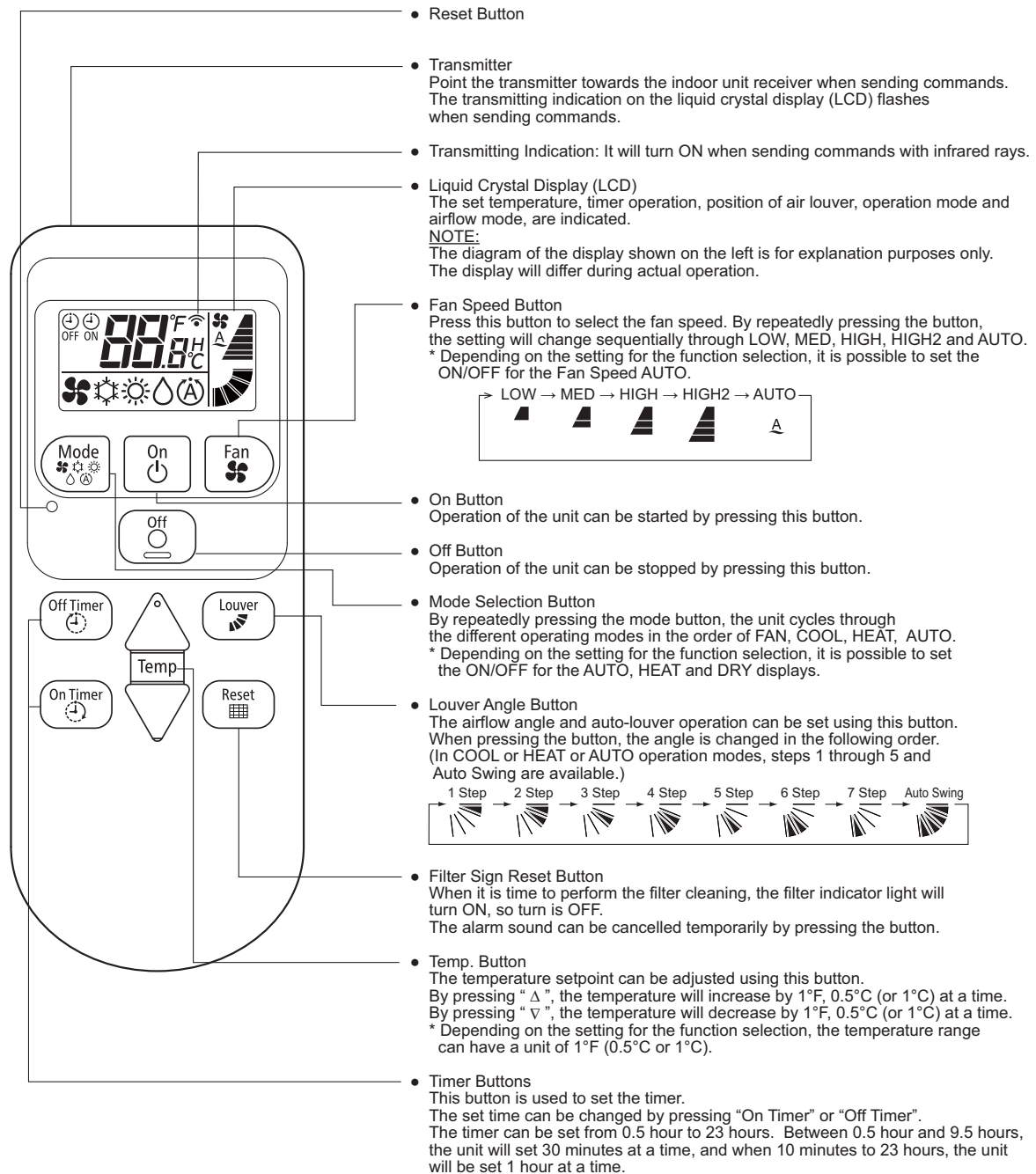

2.4 Handling Wireless Controller

NOTE

- Do not put the wireless controller in the following high-temperature environments. Heat may prevent it from operating correctly.
 - * Places of direct light, including sunlight.
 - * Places where hot air from a heater, or something similar, will affect it.
 - Handle the wireless controller with care. If it falls or is splashed with water, the wireless controller may fail to operate.
-

2.4.1 Sending Commands from Wireless Controller

- The operation commands are sent by pressing the required operation button and pointing the transmitter of the wireless controller toward the receiver of the indoor unit.
- When commands are sent from the wireless controller, it should face vertically and be as close as possible to the receiver kit. The transmission distance will reduce in length when Wireless Controller is not vertical to the receiver or if there is electrical interference in the room.
- The wireless controller requires line of sight connection with the receiver.
- The transmission distance will reduce as the batteries lose power. If this occurs, replace the batteries.

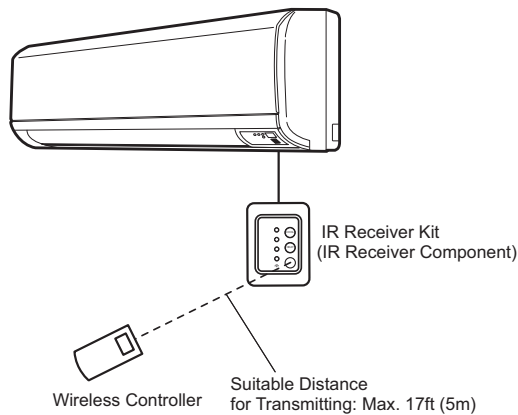

(The figure is example for the wall mount indoor unit.)

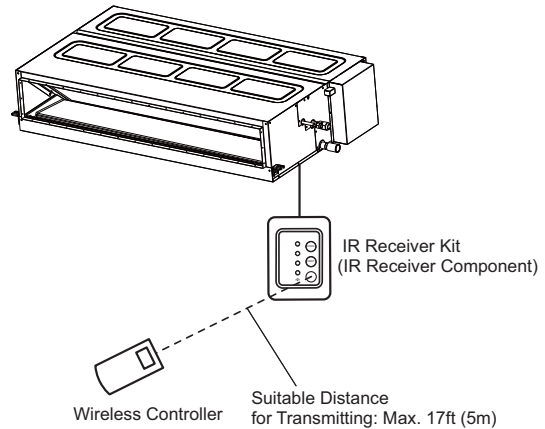



(The figure is example for the ducted indoor unit.)

2.4.2 Horizontal Distance Limit for Receiver Kit

The receiver kit is installed onto a wall. The horizontal distance limit is a maximum of 17 ft (5m).

2.4.3 Receipt Confirmation of IR Receiver Kit

The “” light (yellow) on the receiver part of the indoor unit is turned ON for an instant when the IR receiver kit receives the commands from the wireless controller. If the “” light (yellow) is not turned ON, the commands may not have reached the receiver. Resend the commands.

NOTE

- The “” light (yellow) is turned ON with a beeping sound for receipt confirmation.
 - The beeping sound may not be heard if there is surrounding noise.
-

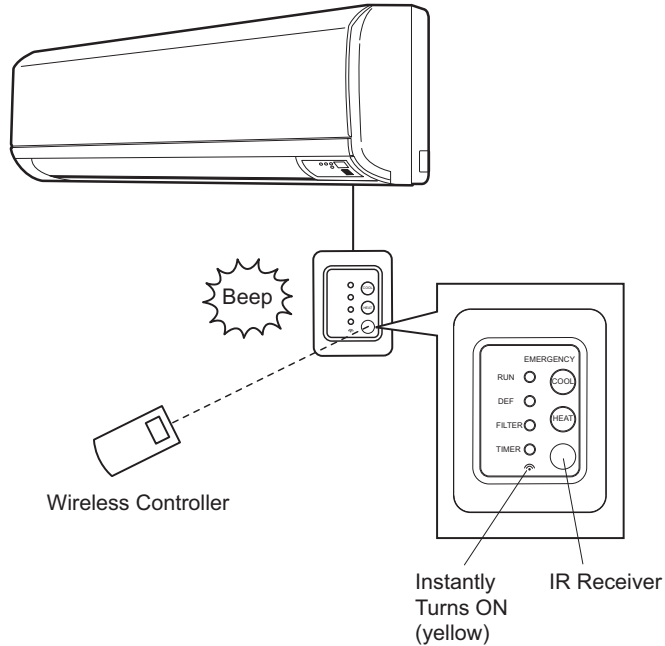



3. Operation

NOTICE







Apply power to the outdoor unit(s) at least 12 hours prior to operation of the system for preheating of the compressor oil. Do not turn OFF the power supply during a change of seasons.

NOTE

- The “” light (yellow) is turned ON with the beeping sound for receipt confirmation.
- The beeping sound may not be heard if there is surrounding noise.
- “” light (yellow) on the receiver of the indoor unit flashes (0.25 second ON/0.25 second OFF), and then turns OFF. While the “” light is flashing, the unit will not operate because it is initializing.

3.1 Basic Operation

< Start Operation >

- (1) Press the “Mode ” button. By repeatedly pressing the “Mode ” button, the unit cycles through the different operating modes in the order of  (Fan),  (Cool),  (Heat),  (Dry), and  (Auto).

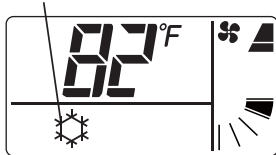

Cooling mode is under operation.



The indications for setting temperature, fan speed, and airflow angle may be turned ON depending on what function is being operated on the control.

NOTE:

For details about the automatic cooling/heating operation mode, refer to Section 3.4 “Automatic Cooling/Heating Operation”.



- (2) Point the transmitter toward the IR receiver kit and press the “On ” button. When the transmitting light “” signals on the LCD of the wireless controller, the “” light (yellow) on the receiver will turn on briefly.

The RUN indicator (red) on the receiver is turned ON when the operation starts.

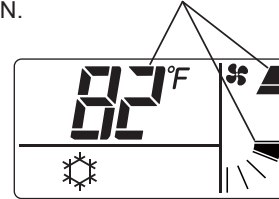
The functions for setting temperature, fan speed, and airflow angle are turned ON.



NOTE:

Do not press the “On ” or “Off ” buttons repeatedly (less than 3 seconds). If the buttons are pressed frequently, the controller may not work correctly.

< Temperature, Fan Speed, and Airflow Direction >

Once the setting is confirmed, the setting condition will be stored. Therefore, a daily setting is not required. In an instance where a the setting change is required, refer to Section 3.3 “Setting Method”.

< Stop Operation >

Point the transmitter toward the IR receiver kit and press the “Off ” button again. The RUN indicator (red) on the receiver is turned OFF and the operation is stopped.

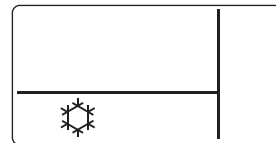

The functions for setting temperature, fan speed, and airflow angle are turned OFF.

NOTE:

The indoor unit fan may continue to operate for up to two minutes following the heating cycle to dissipate residual heat from the indoor unit.

3.2 Operation Mode (Cooling, Heating, Dry, Fan, and Automatic Cooling/Heating Operation)

<Function>

- Fan Operation (Fan):
Circulates the air in the room.
- Cooling Operation (Cool):
Decreases the room temperature.
- Heating Operation (Heat):
Increases the room temperature.
- Dry Operation (Dry):
Decreases the humidity in the room.
- Automatic Cooling/Heating Operation (Auto):
Cools and heats with automatic change-over.

3.3 Setting Method

NOTE

- The “” light (yellow) is turned ON with the beeping sound for receipt confirmation.
 - The beeping sound may not be heard if there is surrounding noise.
 - To adjust the airflow angle, refer to the installation and operation manuals of the indoor unit.
-

3.3.1 Temperature Setting

Point the transmitter towards the IR receiver kit and press the “Temp ” button to set the temperature.

By pressing “”, the temperature is increased by 1°F (0.5°C).

By pressing “”, the temperature is decreased by 1°F (0.5°C).



In this example, the set temperature is 82°F (28°C) in the cooling operation.

NOTE:

- The temperature is not displayed during a shutdown. If the temperature is set during a shutdown, the temperature indication is turned ON temporarily. It automatically turns OFF after being set.
- The temperature can be set for each operation mode.
- The temperature set-point can be set from 62°F (17°C) to 86°F (30°C) by the wireless controller button.
However, for the indoor unit where the temperature set-point range is 66°F (19°C) to 86°F (30°C), the temperature settings of 62°F (17°C) and 64°F (18°C) are not an option.

3.3.2 Fan Speed

Point the transmitter toward the IR receiver kit and press the “Fan ” button to set the fan speed.

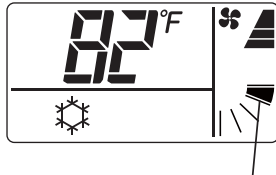

The louver angle is set to 1 step at “High” in the cooling operation.

By repeatedly pressing the button, the setting will change sequentially through Auto, Low, Med, High and High2.

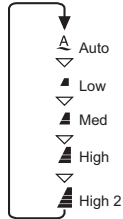

NOTES:

- The fan speed is not displayed during the stoppage. In the case that the fan speed is set during the stoppage, the fan speed indication is turned ON temporarily. It is automatically turned OFF after setting.
- The fan speed can be set for each operation mode. However, the fan speed will be fixed at “Low” in dry operation.









3.3.3 Airflow Direction

- (1) Point the transmitter towards the IR receiver kit and press “Louver ” button to set the louver angle.



The louver angle is set on 1 step at “High” in the cooling operation.

- (2) By pressing the “Louver ” button, the louver angle will change as follows.

Step	LCD Indication	COOL, DRY	HEAT, FAN
-		Auto-Swing	
1		Recommended Angle	↑
2			
3		Angle Range	↑
4			
5		Angle Range	↑
6			
7		Recommended Angle	↓
			

: Auto swing operation will be started. At this time, the louver will swing repeatedly on the LCD.

NOTE:

- The louver angle is not displayed during a shutdown.
- The louver settings are only available from 1 step through 5 steps and the auto-swing at the cooling and dry operation modes.
- The louver angle may change automatically during the heating operation. (Refer to the installation and operation manuals of the indoor unit for details.)
- The louver may NOT stop immediately after the button is pressed.
- The auto louver mechanism is not available for duct-type units.
- To adjust the louver angle, refer to the installation and operation manuals for the indoor unit.

3.4 Automatic Cooling/Heating Operation

< Function >

The Automatic Cooling/Heating Operation automatically switches cooling and heating operation based on the set temperature for inlet air temperature conditions.



The cooling operation is performed when the inlet air temperature is approximately 5°F (3°C) higher than the set temperature.

The heating operation is performed when the inlet air temperature is approximately 5°F (3°C) lower than the set temperature.

NOTE

- If the fan speed is set to “Low” during a heating operation, the operation stops by activating the protection devices. In this instance, set to “Med”, “High” or “High 2”.
 - The heating operation is not possible when the ambient temperature is higher than approximately 70°F (21°C).
 - The threshold of switching the temperature against the temperature set-point is $\pm 5^\circ\text{F}$ ($\pm 3^\circ\text{C}$) when using this function. Therefore, this function should not be utilized in a room where accurate temperature and humidity controls are required.
-

< Start Operation >



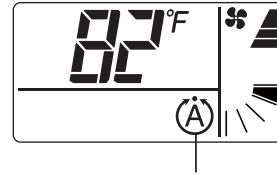

- (1) Press the “Mode  ” button several times. The indication “Auto  ” (automatic cooling/heating operation) will appear.



“Auto” is set.

The functions of setting temperature, fan speed, and airflow angle are turned ON depending on what function is being operated on the control.



NOTE:

- The automatic cooling/heating operation requires more settings to be executed. Please contact your contractor for more details.
 - When the “Mode  ” button is pressed at “Auto  ”, the fan operation is started.
- (2) Point the transmitter toward the IR receiver kit and press the “On  ” button. When the transmitting indication “  ” flashes, the “  ” light (yellow) on the receiver will appear briefly. The RUN indicator (red) on the receiver turns ON and the operation starts.

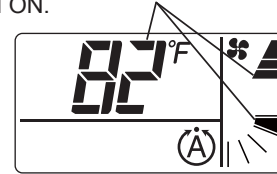
The indications of setting temperature, fan speed, and airflow angle are turned ON.



NOTE:

Do not press the “On  ” or “Off  ” buttons repeatedly (less than 3 seconds). If the buttons are pressed repeatedly, the wireless controller may not work correctly.

< Temperature, Fan Speed and Airflow Direction >

To set the temperature, fan speed, and airflow direction, refer to Section 3.3 “Setting Method”.

3.5 Timer Setting Method

< Stop Operation >

Point the transmitter toward the IR receiver kit and press the "Off" (🔌) button again. The RUN indicator (red) of the receiver is turned OFF and the operation stops.

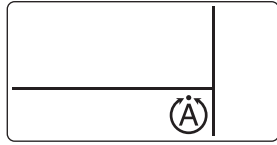

The indications of setting temperature, fan speed, and airflow angle are turned OFF.

NOTE

- The "📶" light (yellow) is turned ON with a beeping sound for receipt confirmation.
- The beeping sound may not be heard if there is surrounding noise.

< Function >

- This function is used to start or stop the unit operation when setting the timer.
- The timer setting set for both an "On Timer" (🕒) and "Off Timer" (🕒).

On Timer: The operation is started after setting the timer.

Off Timer: The operation is stopped after the set time has passed.

< Timer Setting >

- Press the "On Timer" (🕒) or "Off Timer" (🕒) button.
By repeatedly pressing "On Timer" (🕒) or "Off Timer" (🕒), the setting time is changed.
- Point the transmitter toward the IR receiver kit and press the "On Timer" (🕒) button to set the time and the LCD of the wireless controller indicates transmission "📶".
- The time can be set at half-hour intervals up to 10 hours and at one-hour intervals up to 23 hours after the 10 hours.

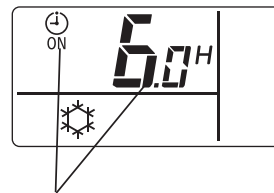

In this example, the setting time for the "On Timer" is set for 6 hours.

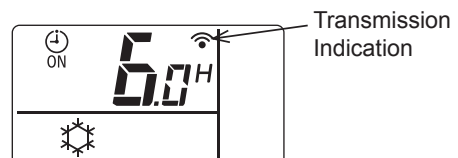

< Cancel Setting >

To cancel the timer setting, point the transmitter toward the IR receiver kit and press the “On Timer 

The TIMER indicator (green) on the receiver is turned OFF.

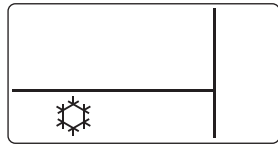

3.6 Emergency Operation

NOTE

- The setting temperature and the fan speed for a cooling/heating operation are the same as before starting an emergency operation.
- During an emergency operation, “

< Function >

“COOL” and “HEAT” buttons are used for an emergency operation when the batteries for the wireless controller are low.

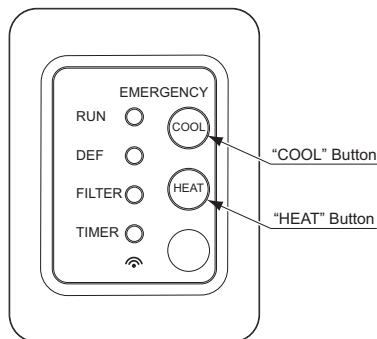

- “COOL” Button: Press “COOL” to begin the cooling operation.
Press “COOL” again so that the cooling operation stops.
- “HEAT” Button: Press “HEAT” to begin a heating operation.
Press “HEAT” again so that the heating operation stops.

3.7 Identifying Indoor Units Installed Side by Side

If two indoor units are installed side by side, the commands from the wireless controller may be received by both indoor units. The function, “Identifying of Indoor Units Installed Side by Side” enables operation of an individual unit correctly without interfering with the other unit’s operation. As shown in the figure below, the indoor units of A and B are set side by side. In this example, unit B is set as “Identifying Indoor Units Installed Side by Side”.

Contact your distributor for additional details.

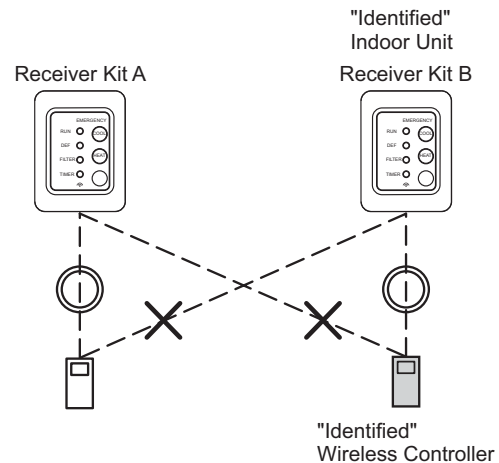

3.8 Simultaneous Operation of Multiple Indoor Units

Multiple indoor units (a maximum of 16 units) can be started and stopped simultaneously by one wireless controller. For details, contact your distributor.

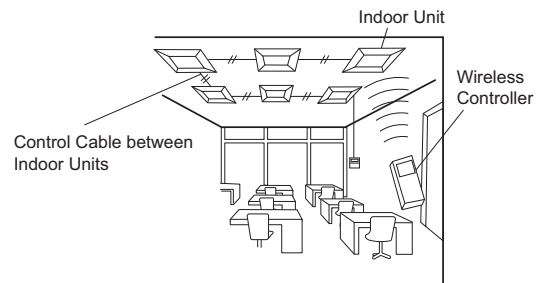

This is an example of Simultaneous Operation of Multiple Units.

3.9 Operation with Wired Controller

The indoor unit can be operated by both wired and wireless controllers. Contact your distributor for details.

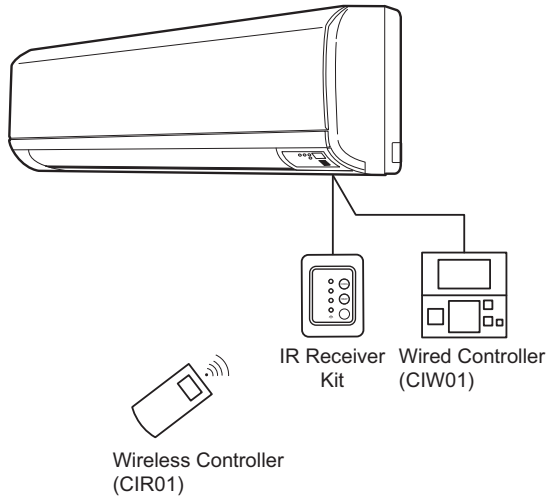

3.10 Automatic Operation

Refer to the installation and operation manuals for the indoor unit.

4. Maintenance

Refer to the installation and operation manuals for the indoor unit.

4.1 Cleaning Wireless Controller

- Wipe the controller with a soft, dry cloth.
- It is important not to use a wet cloth to clean. It may cause damage to the wireless controller.
- Do not use benzine, thinner or detergent (Surfactant). If it is used, the wireless controller may be damaged or change color.

4.2 Replacing Batteries

Under normal use, the battery life should be about one year (for alkaline batteries).

Replace the batteries if one of the following circumstances occurs:

The transmission distance between the controller and the IR receiver kit is too short for operation or fan speed adjustment.

- (1) Remove the battery cover by sliding and pushing the cover in the direction of the arrow as shown in the figure below.
- (2) Set the batteries. (Insert the batteries according to the + and - marks on the case.)

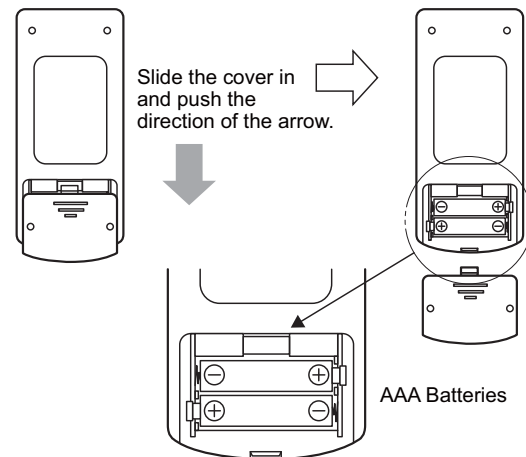

NOTE:

- Review the following to ensure using the batteries correctly. Not doing so may cause a leak or flare.
 1. Never use new and used batteries together.
 2. Never use different types of batteries (for example, manganese and alkaline) together.
 3. When the wireless controller is not used for a length of time (more than two or three months), replace the batteries from the wireless controller.
- The batteries included at the factory are for validation and may be low.
- When replacing batteries, wait for more than 5 seconds after removing the old batteries to replace with new ones.
- All settings are reset after the batteries are replaced. Therefore, when “Identifying of Indoor Units Installed Side by Side” is set, this setting is canceled once the batteries are replaced. After replacing the batteries, set the “Identifying of Indoor Units Installed Side by Side” again. (Press and hold the “ON TIMER” and “OFF TIMER” simultaneously for 3 seconds. The indication “” will appear. Refer to the installation manual for details.)

5. Indications of IR Receiver Kit

5.1 In Normal Condition

5.1.1 Defrost

- Defrost Operation
DEF indicator (green) is turned ON during defrosting. The indoor fan stops. The louver is fixed at the horizontal position. However, the louver indication of the LCD continues to activate.
- Operation Stoppage during Defrosting Operation
The RUN indicator (red) is turned OFF when the operation is stopped during defrosting. However, the operation continues when turning on the ON DEF indicator (green), and the unit is stopped after the defrost operation is finished.

5.1.2 Filter Sign

When the filter indication LED turns yellow, the air filter needs to be cleaned or replaced. (Details for the cleaning method and filter cleaning time should be referred to in the installation and operation manuals for the indoor unit.) After cleaning, point the transmitter toward the IR receiver kit and press the “RESET” button to turn OFF the FILTER indicator.

5.1.3 Central Control

When the “” light (yellow) remains turned ON, the indoor unit is under centralized control. In this instance, “RESET” and “RUN/STOP” buttons are only available for control from the wireless controller.

5.2 In Abnormal Condition

5.2.1 Abnormality

- If a malfunction occurs, such as a safety device actuation, during the test run or the normal operation, the "RUN" (red light) flashes (0.5 second ON/0.5 second OFF).
- The alarm codes are indicated by the flashing of "DEF" (green light) and "FILTER" (light). The first LED light is green. The number of times this LED flashes (0.5 second ON and OFF) will tell you the "DEF" Alarm Code. The second LED light is yellow. The number of times this LED flashes (0.5 second ON and OFF) will tell you the "FILTER" Alarm Code.

< Example >

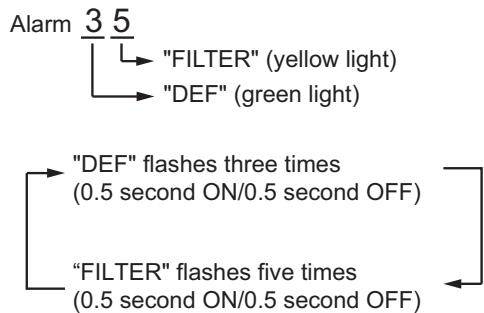

These signals are repeated until the alarm is reset.

5.2.2 Power Failure

- All the indications are OFF.
- Once the unit is stopped by a power failure, it will not start again even if the power recovers. Perform the starting procedures again.
- If there is a temporary instantaneous power failure lasting 2 seconds, the unit will start again automatically.

5.2.3 Electromagnetic Interference (EMI)

There could be a situation where all the indications are OFF and the unit is stopped. This is a result of the micro computer activating protection for the unit because of the EMI. Perform the starting procedures again.

6. Troubleshooting

6.1 This is Not Abnormal

Refer to the installation and operation manuals for the indoor unit.

Phenomenon		Cause and Action
Stopped Operation	All indication lights on the receiver kit are turned OFF.	The micro-computer is activated to protect the device from electromagnetic waves. The operation can be recovered if it is started from the beginning.
	Power failure occurs.	Start the operation from the beginning.

6.2 Before Contact

Check the issues before contacting the distributor.

Refer to the installation and operation manuals for the indoor unit.

Issue	Checking Point	Action
Not Operating	Is the transmitter of wireless controller pointed toward the IR receiver kit?	Point the transmitter toward the receiver kit.
	Check batteries of wireless controller.	Replace batteries.
	Is the receiver surface covered by dust?	Wipe the receiver with a soft, dry cloth.
	Is the air conditioning controlled by a centralized control?	When the air conditioning is under centralized control, "RESET" and "RUN/STOP" buttons are only available for control from the wireless controller.
Not Cooling or Heating Well	Check that the operation mode is correct.	If the fan mode is selected, switch the operation mode to cooling (heating).
	Check that the set temperature is correct.	If not, change the set temperature by pressing "△" or "▽" with the wireless controller.
	Check that the airflow direction is correct.	If not, change the airflow direction.

6.3 Contact Distributor

If the trouble still remains even after checking the previous issues or other problems not mentioned, stop using the product and contact your distributor.

WARNING

If an abnormality (burnt odor, for example) occurs, stop the operation and turn OFF the main power source immediately. Otherwise, there may be damage to the product, an electric shock or a fire. Contact your distributor.

Trouble	Action before Contact
The protection devices such as a fuse, breaker or Ground Fault Circuit Interrupter (GFCI) are frequently activated or the main power source does not work.	Turn OFF the power source.
Water Leakage from Indoor Unit.	Stop the operation.
<ul style="list-style-type: none">• The RUN indicator (red) is flashing.• The alarm codes are indicated by the flashing of DEF indicator (green) and FILTER indicator (yellow). Check the details for flashing indicators and contact your distributor. (Refer to Section 5.2.1 "Abnormality".)	Refer to the alarm code table of the installation manual for the indoor unit. Inform your distributor of the details of the flashing indicator of the IR receiver kit.

Provide the following information to the distributor.

- 1) Model Name**
- 2) Description of Problem**
- 3) Alarm Code Numbers or Details of Flashing Indicator (Refer to Section 5.2.1 "Abnormality" for details.)**

